



DIVEVOLK Intelligence Tech Co.,LTD.

www.divevolk.com

ABOUT US

ABOUT DIVEVOLK



The DIVEVOLK team is proud to be a group of people who never compromise on their dreams. We are committed to the research and development of intelligent equipment for underwater communication and interconnection, providing brand-new experiences for global enthusiasts of diving and water sports, and continuously improving underwater safety.

In order to make our dreams a reality, the DIVEVOLK team has spent more than 700 days and nights testing more than 100 combinations of materials and technical processes, creating the first generation of mobile intelligent control terminal. The first step in this vision is the creation of the SeaTouch series of underwater full touch screen smartphone housing, SeaHear high-fidelity underwater earphones, and SeaLight synchronized flashing lights. At the same time, continuous R&D and innovation work has enabled DIVEVOLK to obtain nearly 40 patents worldwide. In the future, a rich underwater intelligent ecosystem for communication, interconnection, and interaction will be fulfilled.





Underwater APP Recommendation

The patented underwater touchscreen technology makes your phone unbound to any function. To use any of your favorite apps, such as Filmic Pro, Lightroom camera or any photography apps to shoot incredible footage, and even some apps might be helpful in many diving scenarios.

Recommended Phone Function

Using the built-in mobile APP can help us solve some problems underwater to a large extent. For example, use the compass to guide the direction underwater, record important things in the note, or pre-enter the diving plan in the notepad, and review it underwater

Using video playback, you can quickly show students the correctness of movement skills in teaching and improve efficiency. For technical divers, watching videos and listening to music underwater are also good ways to pass decompression stops.



- Music
- Note
- Video
- Compass



Filmic Pro

- Recomended Function**
- Dynamic range mode
 - White balance adjustment
 - Manual mode

This is a film and television-level shooting app loved by professional photographers, which incorporates a large number of professional shooting functions. Shooting in Log format allows the video to retain more details for color grading. The dynamic range mode selection similar to that of a DSLR camera provides users with more creative ways. The color palette can preset the color of the picture to better restore the underwater color when shooting. Using the APP, you can also manually select the focus, focal length, frame, etc., allowing users to shoot cinematic look.

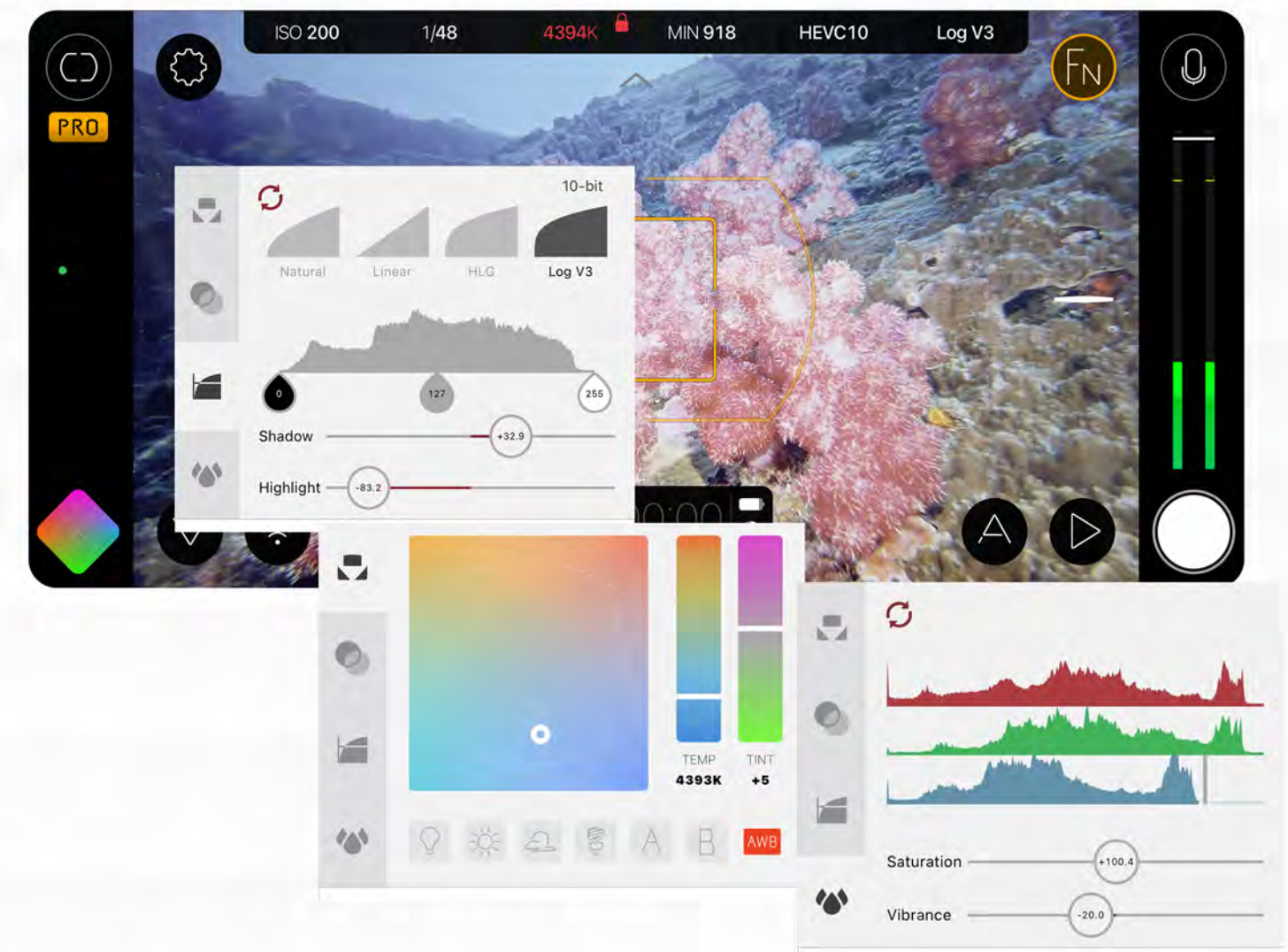



ProMovie

Recommended Function

- Manual mode
- Quick manual white balance

An easy-to-use and powerful video recording APP, the simplicity of the user interface, large icons and other features make this APP very friendly to operate underwater. In the automatic mode, a single camera parameter can be adjusted to achieve quick control of the filming. In full manual mode, parameters can be precisely controlled to produce professional content.



Lightroom

Recommended Function

- Professional mode
- Raw file
- Manual white balance

It is famous for its photo adjustment, also has a professional camera function, which may not be known to many people. Not only can you take photos in RAW format to record more profile data, but you can also enter the professional mode to adjust shutter speed, ISO, white balance, etc. And you can call up functions such as highlight clipping and level meters to assist in shooting.



Double Take

Recommended Function

- Film with 2 cameras

The use of Double Take maximizes the advantages of the multi-camera of the mobile phone, and can select any two cameras to shoot at the same time. You can also choose the combination of rear camera + selfie camera, so that you can also record yourself while filming. You can also use two rear cameras, such as ultra-wide lens + telephoto lens, which can not only capture the panorama of the subject, but also get a partial close-up without cropping the video. Provides creators with more framing options.



Camera +

Recommended Function

- Macro mode
- Action mode
- Slow shutter

The power of this APP is that it has preset camera modes for different usage scenarios. The macro function allows the phone to capture exquisite details, the action mode is specially designed for moving objects, and the slow shutter function can capture unique pictures in specific scenes. At the same time, it can also take photos in RAW format and manually adjust the camera parameters.

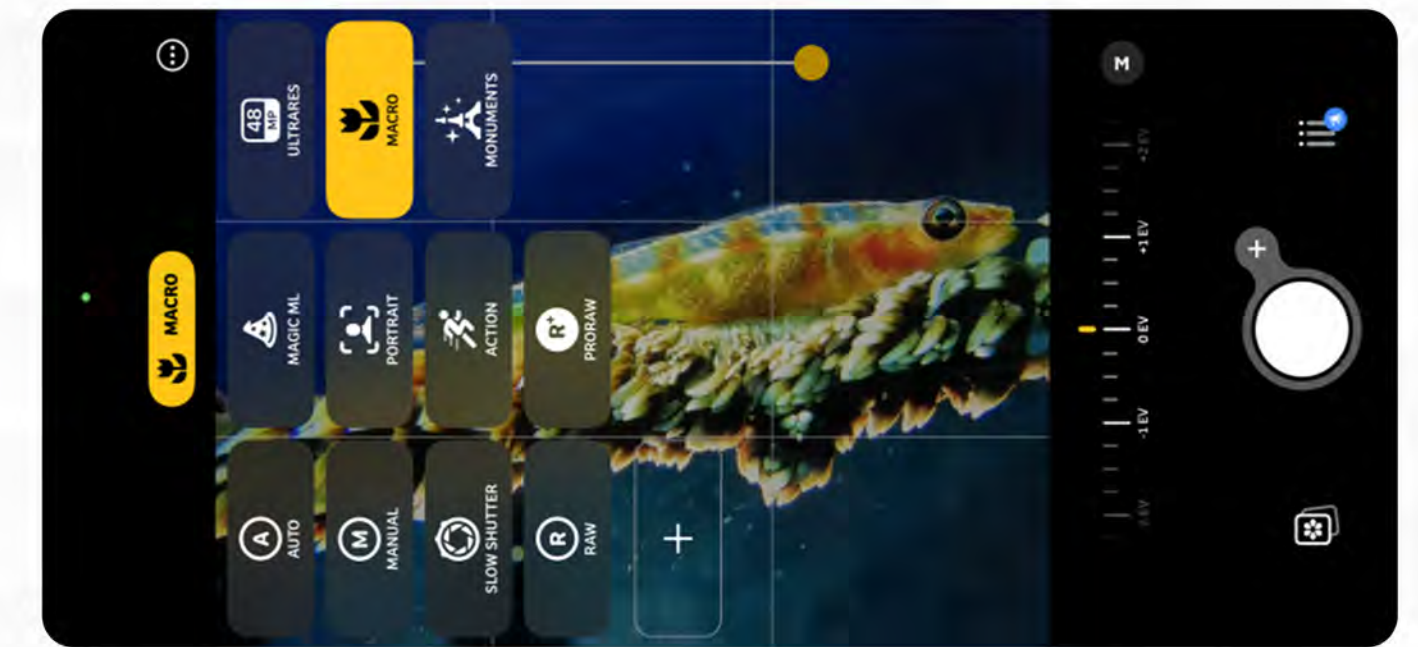



Musemage

Recommended Function

- Filter and effect

The use of various special effects that comes with the APP allows creators to find new ways to create interesting and unique content. In addition, Musemage is also a powerful shooting software, providing powerful anti-shake, beauty, manual mode and other functions.

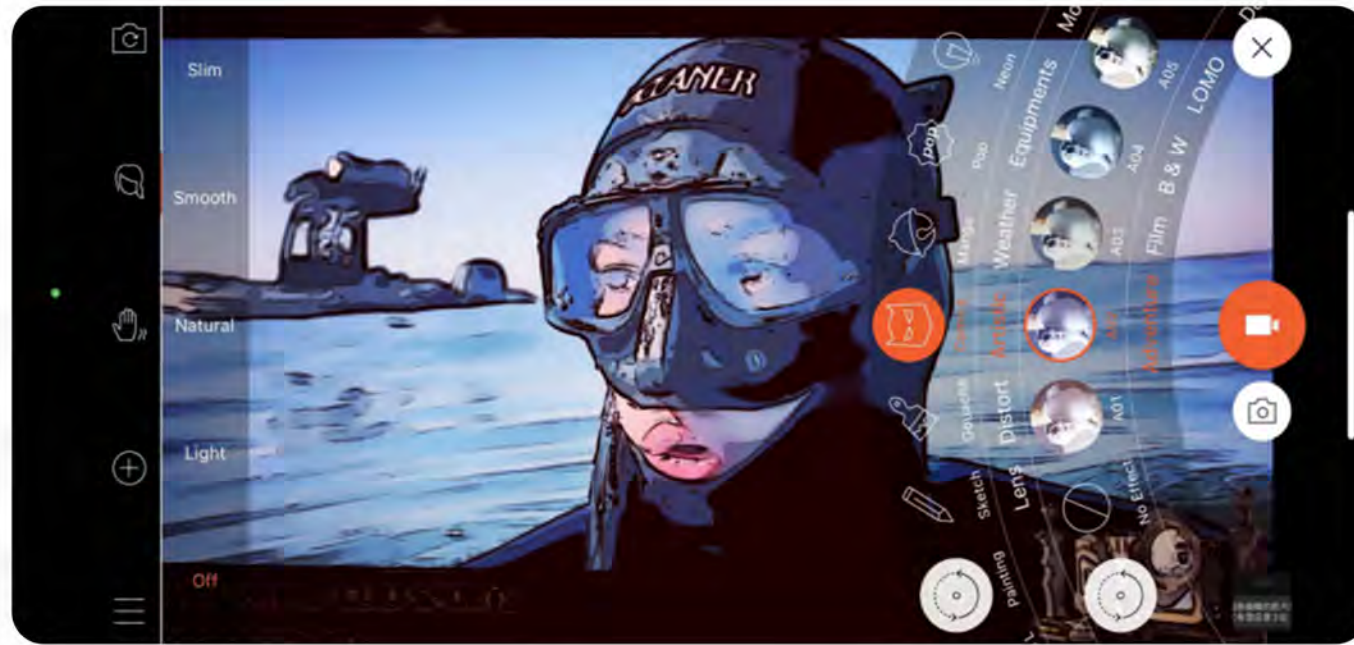

Protake

Recommended Function

- Display enlarge
- Incorporates all professional shooting features

The integration of various powerful functions makes Protake a shooting app that can be called a PRO level. Manual mode adjustment parameters, white balance adjustment, beautification, dual camera calls, etc., it can be said that all professional functions that can be thought of have been included. There is also an impressive function, which can enlarge the display on the video screen to observe the subject without zooming in on the focal length of the camera to crop the screen, increasing the photographer's creative success rate.

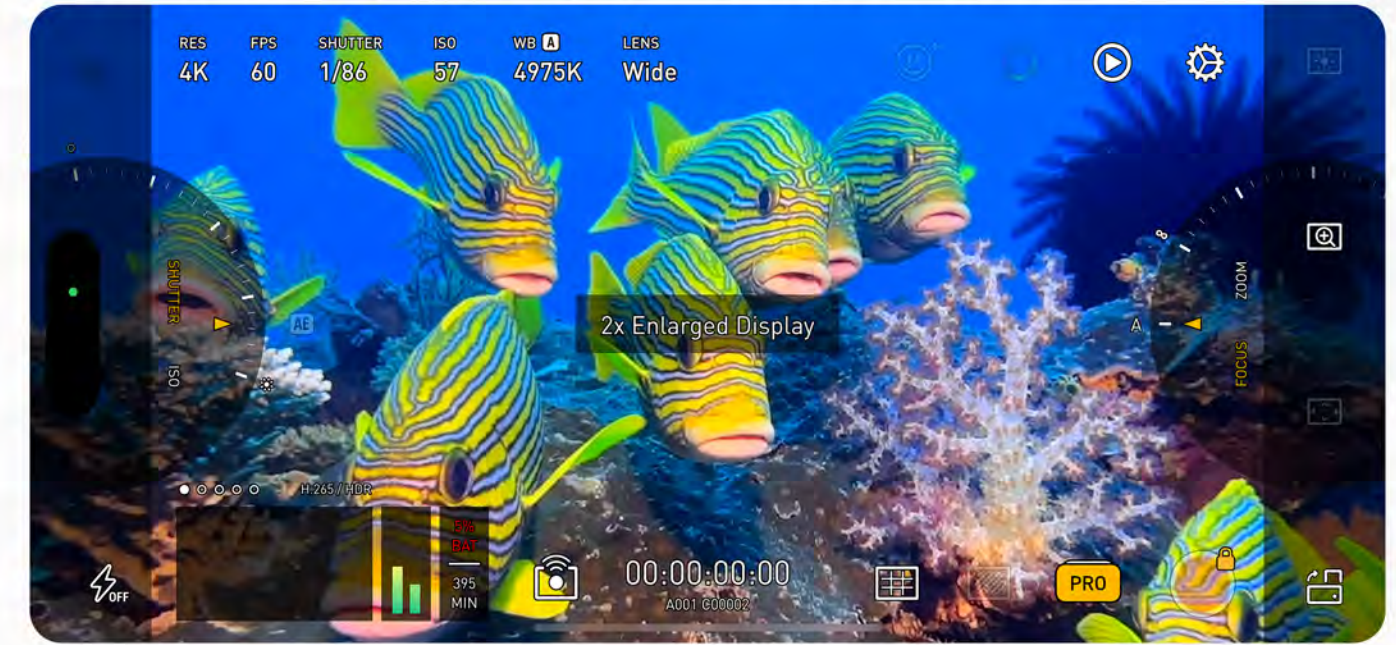

Linne Lens

Recommended Function

- Fish and sea creature recognition

Not only can animals be quickly identified on land, but also most fish and underwater creatures can be quickly and accurately identified underwater when the mobile phone is offline, making Linne Lens a powerful underwater science popularization tool. With it, you can not only identify the creatures you see underwater, but also record and automatically classify them, and generate an illustrated book of underwater creatures for you.



LED Banner

Recommended Function

- Underwater typing
- Large character carousel

We can't speak underwater. When we can't express some complex words with diving gestures, typing and showing them on the phone is a good way to communicate. After inputting words, LED Banner can also enlarge the text and play back and forth in the form of a marquee. In this way, even if the diving partner is at a certain distance, he can see the content of the screen and know what the other is saying. It greatly improves the safety of diving.



Compared with other button-type smartphone housings, the revolutionary **SeaTouch 4 Max** can access all phone functions by touchscreen without restriction underwater. No matter whether it is on the surface, or at a depth of 60 meters, you can use all your phone's apps freely.

The SeaTouch 4 Max has greater phone model compatibility and more optimized underwater touchscreen structure.

This is



REAL UNDERWATER TOUCH SCREEN



ACCESS TO ALL APPS UNDERWATER



EMERGENCY CONTACT



BUTTON-FREE DESIGN



60M WATERPROOF



IPX8 WATERPROOF STANDARD

Max

SeaTouch 4 Max Underwater Full Touchscreen Housing

Model #	DADDB
Waterproof	60m/196ft
Sensitive Touchscreen	Above 30m/98ft
Applicable models	Applicable to smartphone models within 180.0 x 82.5 x 11.2mm (length x width x thickness), the thickness of the lens of the phone should not exceed 13.5mm



Features

SeaTouch 4 Max

Button-operated Housing

Bluetooth connected Housing

Access to all phone functions	✓	camera only	camera only
Access to all native camera functions	✓	Limited function	Limited function
Switch to ultra-wide angle, telephoto camera function Free to select focus anywhere by tapping the screen	✓	✗	✗
Quick EV adjustment	✓	✗	✗
Manual mode Raw file image shooting	✓	✗	✗
Compatible with all photography apps,(ie. Filmic Pro, Slow Shutter)	✓	✗	✗
Underwater music, audio or video replay	✓	✗	✗
Underwater compass, longitude and latitude information access	✓	✗	✗
Text on memo or demonstrate the words to others	✓	✗	✗
Bluetooth or Wifi connection to other devices	✓	✗	Housing Only
Emergency phone calls or video calls on surface	✓	✗	✗
Instant upload and sharing without removing phone from housing	✓	✗	✗
Applicable to various water sports	✓	Limited	Limited

THE SAFETY OF YOUR PHONE IS OUR FIRST PRIORITY

From the very initial stages of development, the safety of the users' phone has been DIVEVOLK's first priority.

From the unique small opening, multi-layer seal gasket, to the button-free design, the waterproof capability is highly superior when compared to the traditional design.



Button-free design

Each button increases the risk of leakage

Small opening

Bigger the opening
more risk of leakage

Three layer gasket

Sealing the opening in all directions

Customized 3D Printed Smartphone Adapter

The SeaTouch series housing is compatible with most smartphone models on the market. You won't have to change the housing when you change your phone. Different size adapters will secure the phone inside the housing.

Specification

The maximum compatible dimensions of a smartphone are :

SeaTouch 4 Max - 180 x 82.5 x 11.2m, lens area has to be thinner than 13.5mm

SeaTouch 3 Pro and Pioneer - 165 x 78 x 8.9m, lens area has to be thinner than 10.5mm

Technicians will create a 3D printed adapter specific to the smartphone model to ensure perfect fit (requires 5-10 business days to ship)

Notice for Users:

The 3D printed adapter is made of heat and UV sensitive material. Please store below 50°C and out of direct sunlight.



SeaLight Series

Diving light for video and photo

Photography is the art of light and shadow.

Through different angles of light, it shows different emotions of the picture. At the same time, through underwater photography lights, the true colors of underwater scenes can be restored.

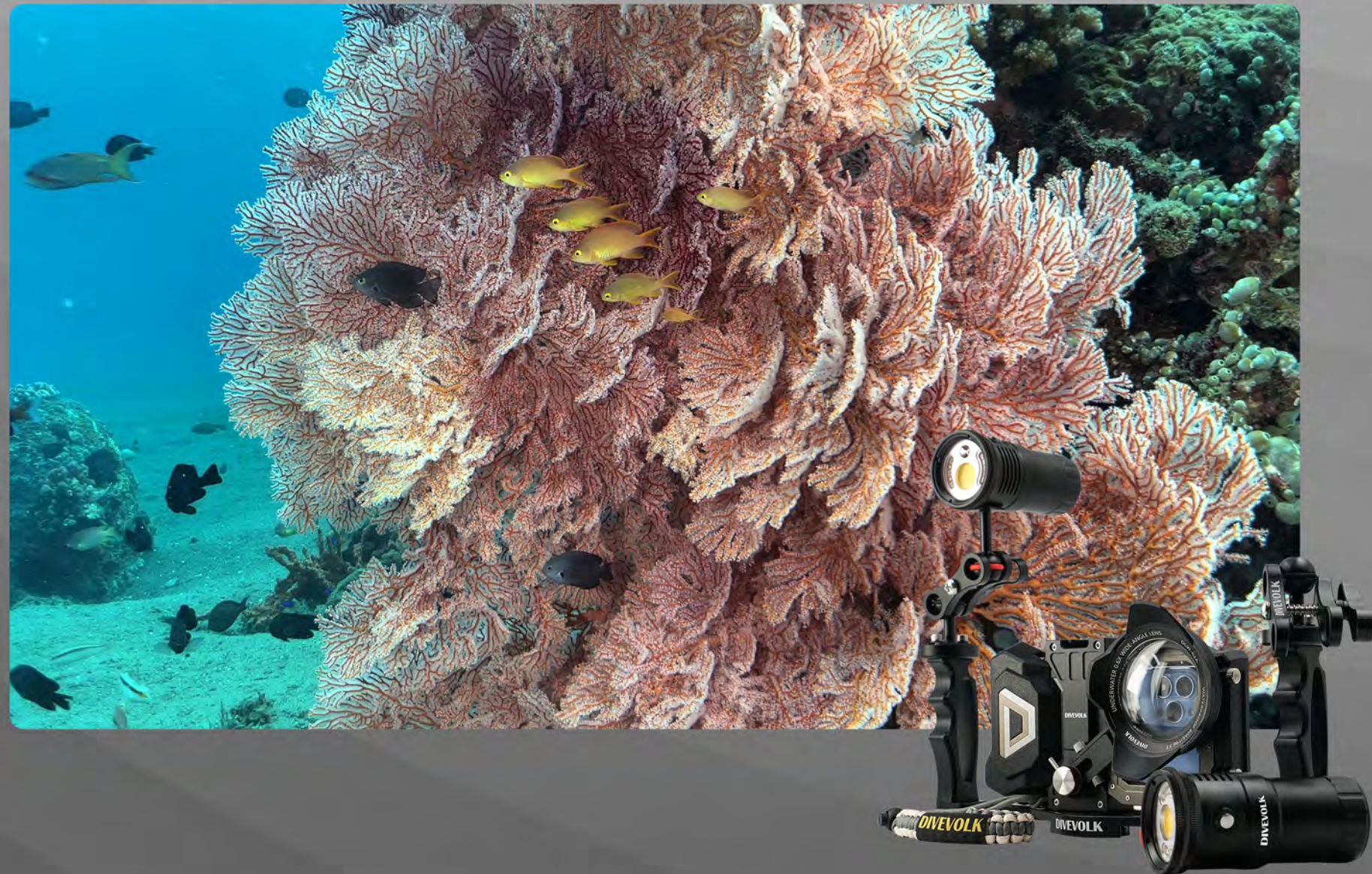

SL50



Waterproof
100m



Wide-angle
Illumination



Long
Battery Life



Multi-level
Dimming

With the SeaLight series diving video lights, you can better experience night dives, wreck ship dives, and a lot more advanced diving scenarios.



SL20

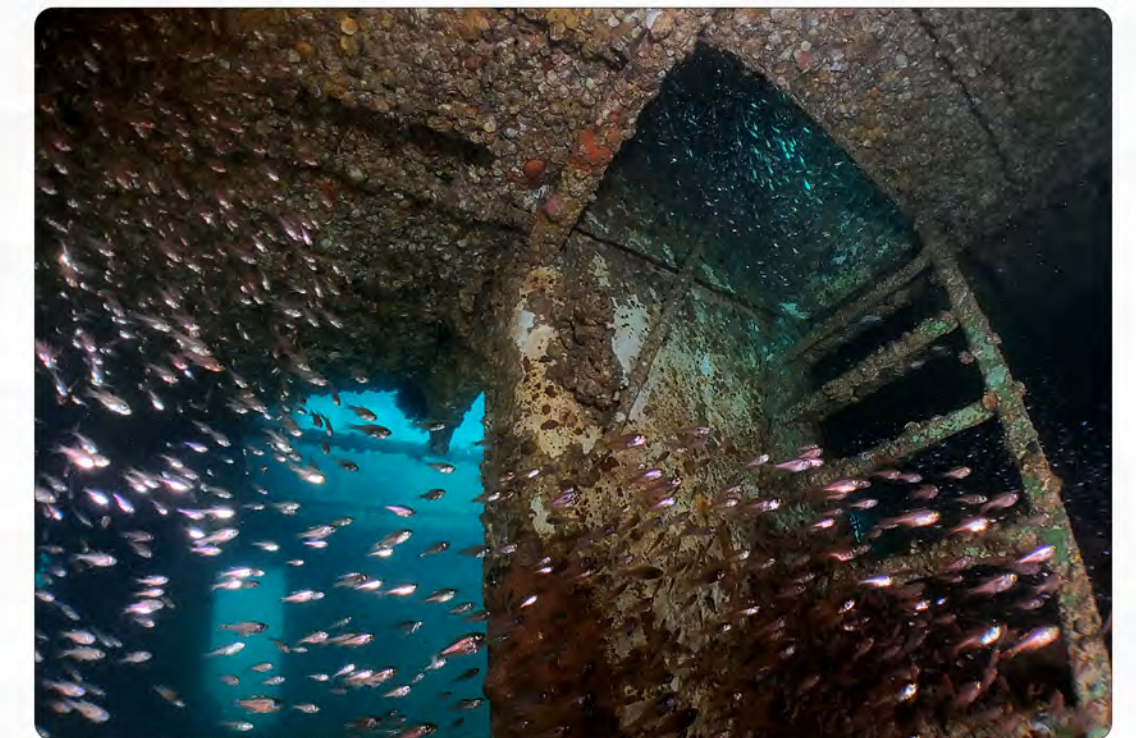

SL50 Underwater Video Light

5000lumens and approximately 50mins runtime

Model # SL50

COB LED of 18mm diameter with a lifespan of up to 50,000 hours

Brightness: 100%→75%→50% (long press for stepless dimming)

Runtime: White light (100%) 50mins

Beam Angle: 120°

Power Indicator: > 70% GREEN; 30% - 70% YELLOW; ≤30% RED

CCT: 5600K; CRI: 96; R9: 94; Color Consistency Index: 97

Battery Pack Capacity: 33.3Wh(11.1V·3.0Ah)

Charging Time: 2-3 hours (DIVEVOLK dedicated charger: 12.6V=2.8A)

Dimensions: 135mm x 46mm x 56mm

Net weight: 490g(on land),320g(in sea).



Size:42 mm x 131 mm



Patent Mechanical Button Switch

Mode: ON → High → Medium → Low → OFF
(Long press for stepless dimming)



Power Indicator: > 70% GREEN ■ 30% - 70% YELLOW ■ ≤30% RED ■

Try with light in different angles to create some special shots. You will never know how creative you are until you have one more try.



SL20 Underwater Video Light

2000lumens , Runtime 150mins

Model # SL20

LED with a lifespan of up to 50,000 hours.

Working Voltage: 2.7V-4.5V.

Maximum Output of Brightness:High light (100%) 2000 lumens, Low light (50%)1000 lumens.

Beam angle: 100°.

Dimensions : 131mm x 32.5mm x 42mm.

Net weight: 260g (on land),156g (in sea).



Patent Mechanical Button Switch

Mode: ON -> High -> Low -> Red -> OFF

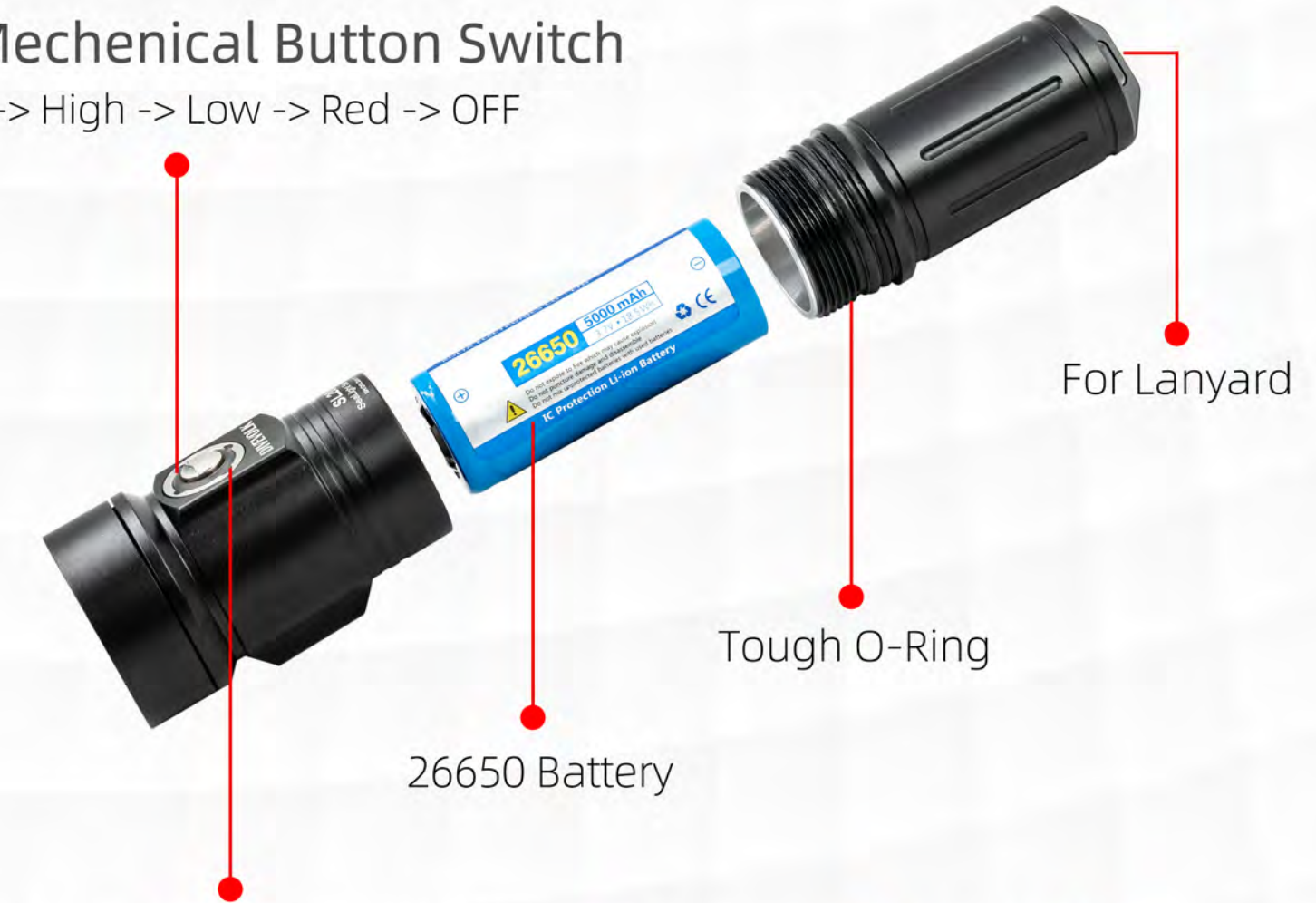

Power Indicator(Power>70% :green ■ <70%yellow ■ <30%red ■)

2000lm illumination is a good lighting condition for close shot, such as nimo, coral in detail. With the light, you can make colorful and clear shot easily.



Expansion Clamp for SeaTouch 4 Max

The expansion clamp and lens adapter are the key extension accessories of the SeaTouch 4 Max housing. With the clamp and adapter, you can attach wet lenses, filters, tray and lights on the housing, to fully equip your housing for different underwater scenarios.

Model # DAD2H67B

Cold Shoe Connector

M6 Thread Hole x 2

To install extension accessories,
like ball head, flexible arm



1/4" Thread Hole x 2

To install stablization accessories,
like tray, tripod



67mm or 52mm Lens Adapter

With different thread sizes, you can attach various types of lens, domes, filters on the housing. Please choose the right thread size according to your lens or filter.

Model # (67mm) DAD67A | (52mm) DAD52A

6 section adjustable

Adjust according to the position of the lens





67mm Red Filter

Model # DLF67R

52mm Red Filter

Model # DLF52B



67mm Magenta Filter

Model # DLF67M



When sunlight enters the water, the warm-colored lightwaves will gradually decrease and disappear at a certain depth. Photos and videos will turn bluish and green, losing the red, orange and yellow colors. Color filters can help restore underwater colors to a certain extent.

Suggested depth of use: 5-25 meters

Red filter is for salty water.

Magenta filter is for freshwater.

Underwater 0.6x Wide-angle Conversion Lens

The DIVEVOLK Underwater 0.6x Wide-angle Conversion Lens not only has the amazing distortion correction ability especially to the ultra-wide lens of the smartphone, but also magnify the view. With the conversion lens, you can exert the full performance of the phone camera.

SPECIFICATIONS

Model #	DLW-02A
Product Name	Underwater Wide-angle Conversion Lens
Lens Construction	2 groups, 2 elements
Working Depth	60m/ 196ft
Underwater FOV	0.6x magnification
Mounting	M67 thread mount
Dimension	115 x 102 x 34 mm
Lens Material	Polycarbonate dome lens with hard coating, anodized aluminum
Weight	120 grams on-land/5 grams underwater



- M67 thread size
- Quickly install and remove under the water
- Obvious distortion correction

With 67mm thread size, the conversion lens covers even the ultra-wide camera of the phone, expanding the already-wide-view even wider underwater. The amazing underwater distortion correction of the lens makes underwater photography more efficient.

Compatibility

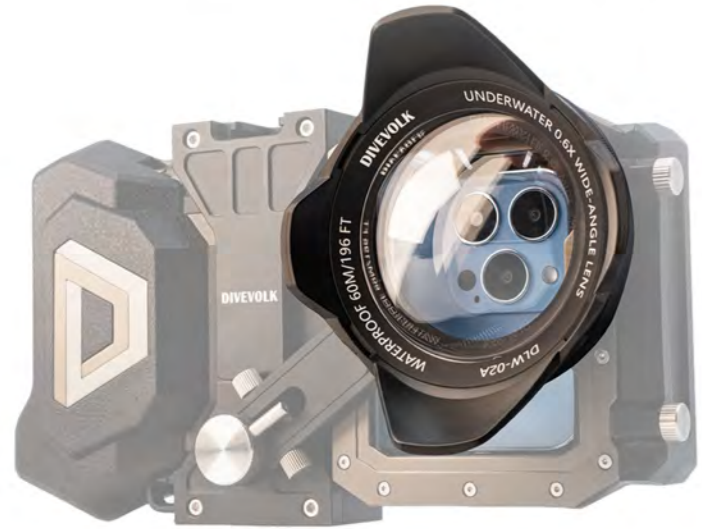

- The underwater weight of this lens is 5 gram only, the almost-neutral-buoyancy makes a good partner of the smartphone.

- This lens can not only apply on smartphones housings, but also on camera housings which have 67mm thread connection port.



BEFORE



AFTER

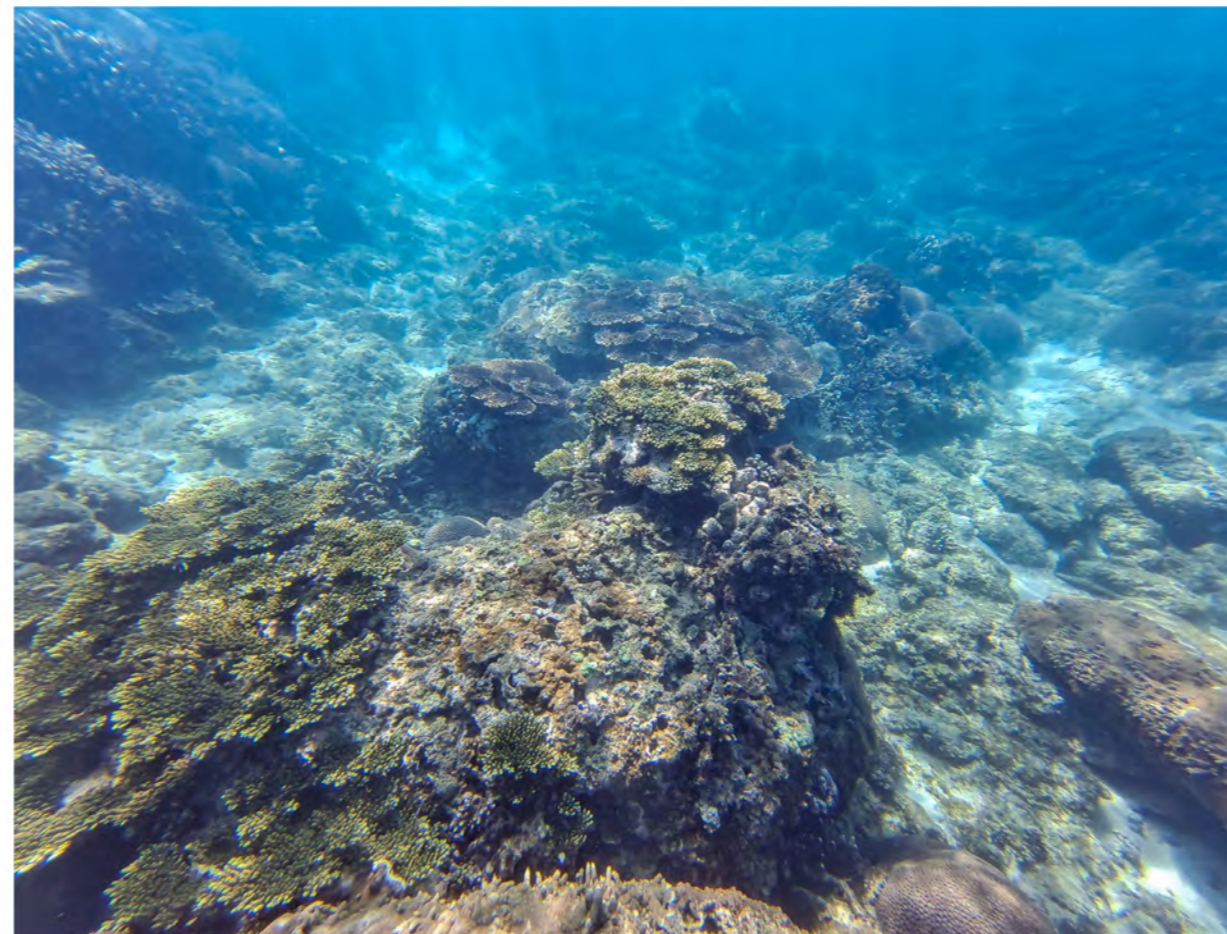

BEFORE



AFTER

Close-up Lens +15



The close-up lens provides the effect of magnification and diopter +15, which allows the camera to focus at a very short distance. Through the close-up lens, photos and videos could be shot with a milky-smooth blurry background.

In order to achieve the best result of using this close-up lens on a smartphone, it's suggested to zoom in 2x or 3x.

Both pictures are shot with iPhone 14 Pro Max



2x camera build-in Macro mode



2x camera with close-up lens + 15

SPECIFICATIONS

Model #	DLM15BD
Waterproof	60m/200ft
Description	Underwater +15 Close-up Lens
Dimension	70mm (D) x 41mm (H)
Thread Size	67mm
Weight	128g(on land) 10g (in sea)

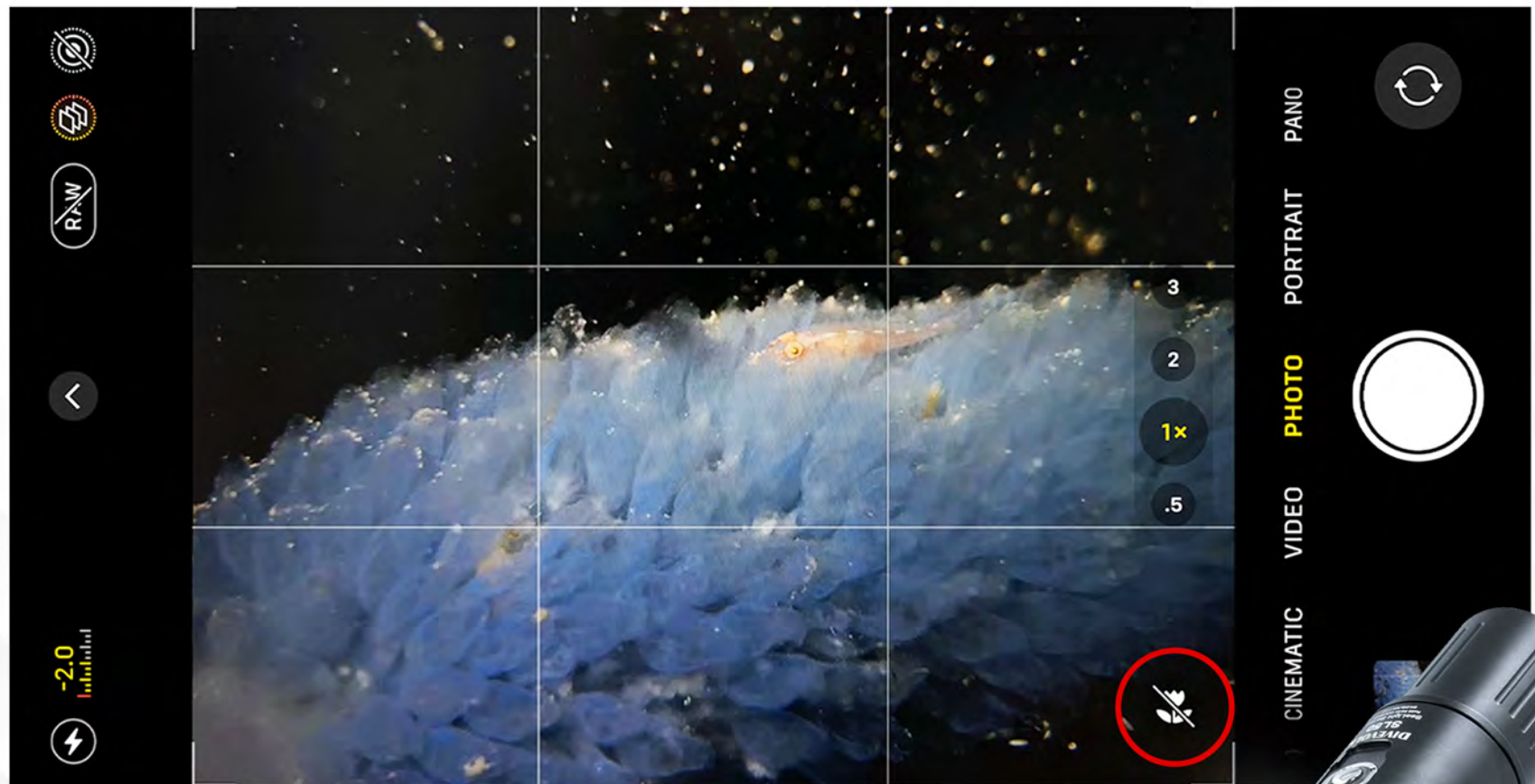

iPhone model has to turn off the MACRO FUNCTION before using.

1. Setting - Camera- Macro Control (on)



2. In the camera screen - Macro icon (off)

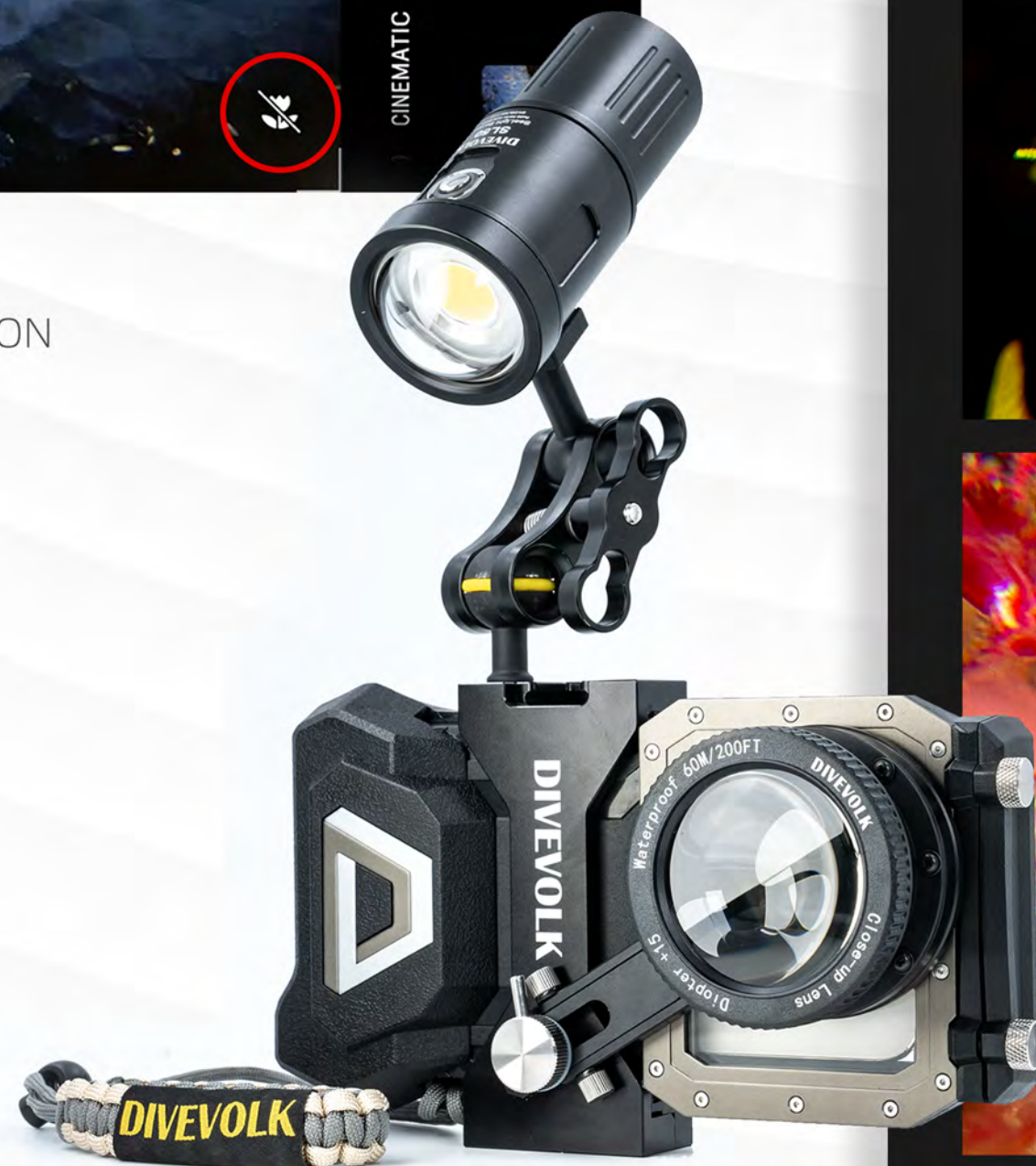

With the DIVEVOLK SL50 or SL20 underwater photography lights, the details of tiny creatures can be clearly photographed. Discover the fun of underwater photography.

Shot on iPhone 14 Pro | SL50 Video Light | Macro Lens +15



Dome Lens for SeaTouch 4 Max



SPECIFICATIONS

Model #	DLW-03D
Waterproof	3m/10ft
Compatible	SeaTouch 4 Max
Dimension	160mm x 160mm x 80 mm
Weight	On land 233g Underwater -250g (Positive buoyancy)



Before and after use

The dome creates a gap that pushes the water away from the phone lens to create split water shots.



Usable up to a depth of 3m/10ft

- Ultra wide angle conversion
- Image distortion correction
- Perfect for snorkelling and pool



How to use

Acrylic Dome

Light transmittance
up to 93%



Built-in buckle

Installation without additional
accessories and tools

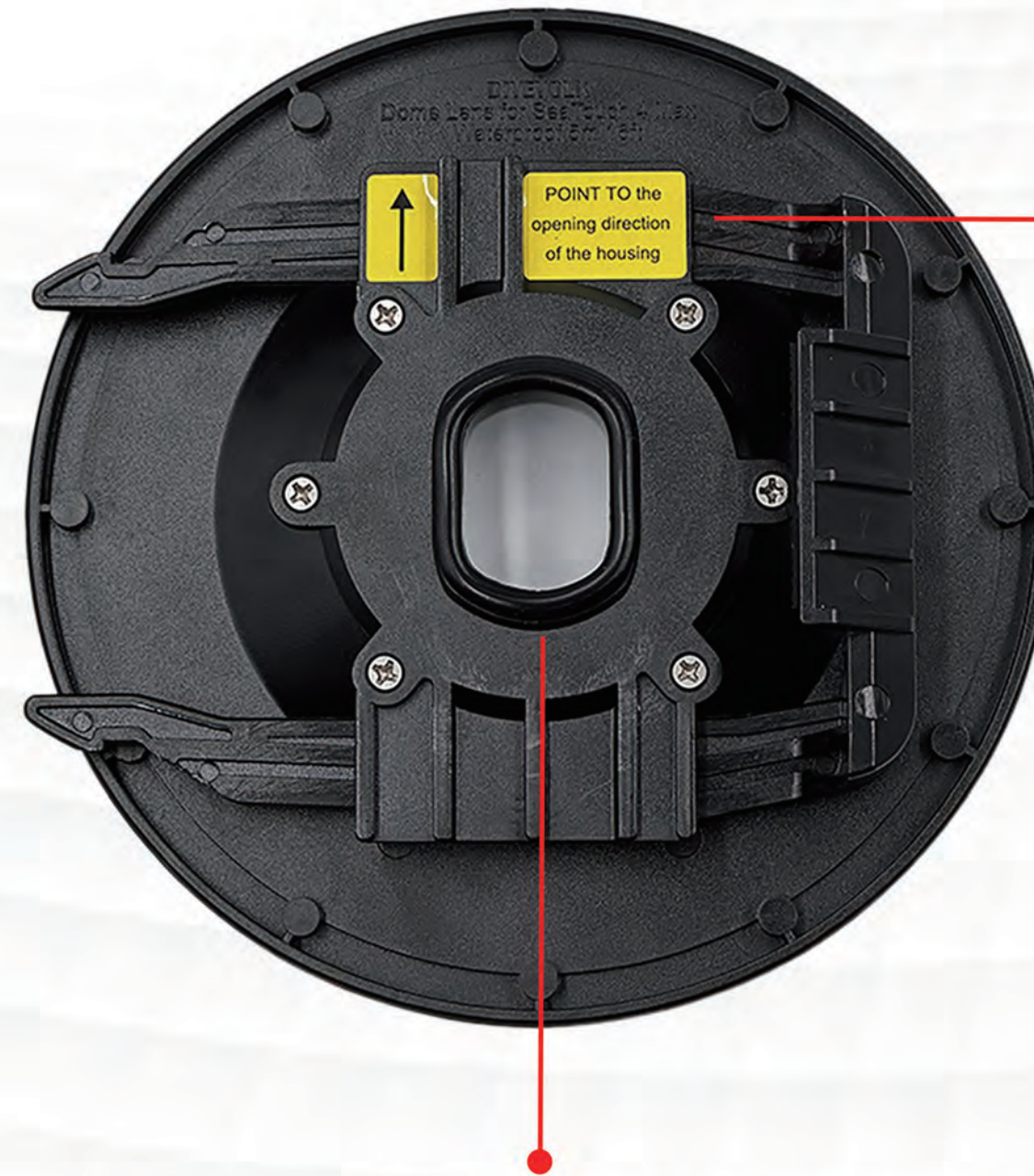

Pay attention to

When installed, the arrow is pointing to the
opening direction of the SeaTouch 4 Max
housing.

Unique design - water separation ring

The reason that the traditional dome could not take split water shot is the water wave between the lens and the housing blurs the phone lens. The unique separation ring keeps the water away to make split shots possible.

Dual Handle Tray

Model # DADDHT

Weight 560g (on land), 365g (in sea)

Specification Adjustable handle spacing

Minimum width 23cm

Maximum width 28.5cm

Compatible with various kinds of camera

housing and smartphone housing



The upgraded connection allows the housing to be tilted when it is not disassembled, making it easy to take out the phone.



Single Handle Tray

Model # DHSB

Specification 1/4" screw mount

Single ball head

EVA foam wrapped handle

Weight 280g(on land), 168g(in sea)

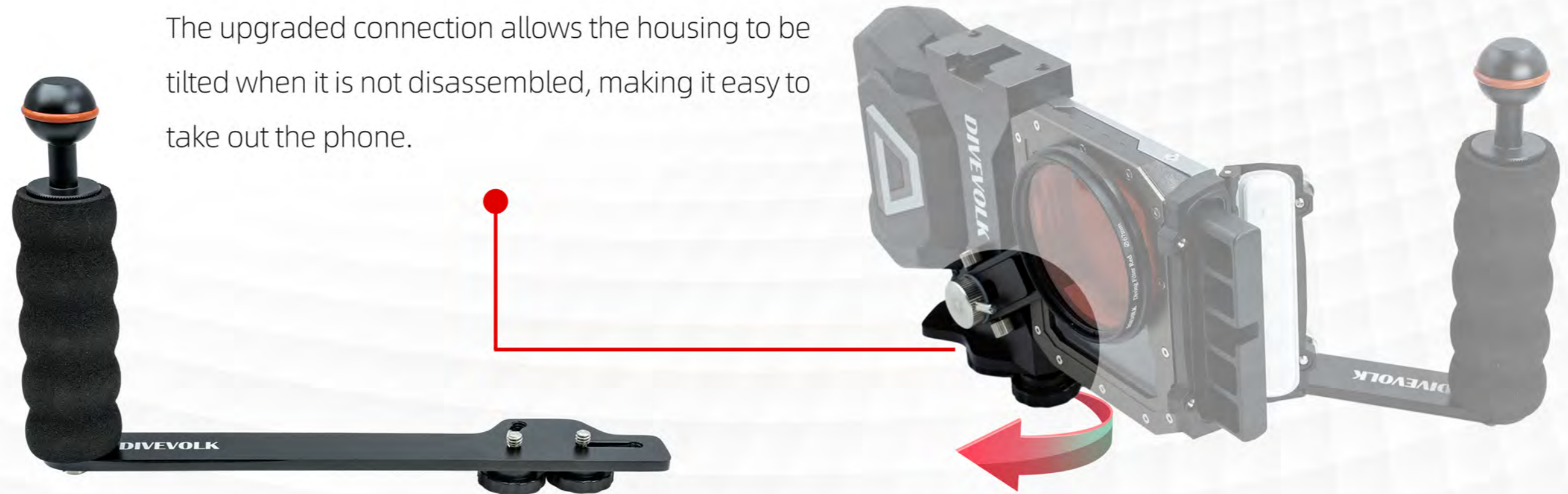

Flexible Arm

Model # DHCSB

Specification Length 18cm

Eva foam cover

Connect on the cold shoe of the expansion clamp

The safety plate prevent your flexible arm from dropping out.



Underwater Flexible Tripod

The feature of this underwater tripod is for underwater use. All the iron part has been replaced by 316 stainless steel. A unique stainless steel balancing weight block is added for steadiness underwater. Moreover, the flexible arms of this tripod adapt different complex scenarios underwater, giving you the opportunity of selfie, macro shot, time-laps video and more creativity.

Model # DHTB



Vertical Horizontal Switching L Bracket

Model #	DHVHS
Material	Aluminum alloy
Specification	144mm x 108mm 1/4" screw connection
Function	To switch the camera from horizontal to vertical



With the trend of social media content creation, it's important to film high-quality content in portrait view to create an immersive experience to audience. The Vertical Horizontal Switching L Bracket is designed for content creators to shoot portrait view easily, no matter whether it is assembling with the dual handle or single handle tray.



Selfie Stick

Model # DHCSS

Specification Minimum length 20cm, maximum length 75mm

1/4" screw and thread hole

With a phone clamp

The selfie stick has to be attached on the expansion clamp



Double Ball Extension Arm 5-inch or 8-inch

Model #	DHDBEA5	DHDBEA8
Material	Aluminum	Aluminum
Length	5-inch	8-inch
Weight	53g(on land)	59g(on land)
	14g(in sea)	-4g(in sea)



Float Arm 447g or 872g

Model #	DHCFA	DHC2FA
Material	Aluminum	Aluminum
Length	27cm	27cm
Weight on land	178g	262g
Buoyancy provided	447g	872g



Triple clamp

Model # DHTBJB

Specification Connect 3 ball heads

Ball head center distance 5cm



Ball Joint Clamp

Model # DHBJB

Specification Connect 2 ball heads

Ball head center distance 5cm



M6 or 1/4" Ball Head

M6 Model # DHCBH

1/4" Model # DHC2BH

Specification Install with M6 or 1/4" threaded screws

It can be installed on the SeaTouch expansion clamp to expand to other tools,
such as: dive light, float arm.



Cold Shoe to Action Camera Conversion Adapter

Model # DHCAC

Material Aluminum alloy

Function Cold shoe to 20 conversion adapter

To connect action camera on the housing



The glass protective film protects the glass of the housing from scratching; the protective cover protects the membrane of the housing from crashing.

Glass Protective Film

Model # DADGPF4

2 pieces per set

Tempered glass membrane



The key component of the SeaTouch housing is the touchscreen membrane, which needs to pay special attention to be protected during the use or transportation. The Camouflage Protective Cover is designed to protect the membrane and the glass.

Camouflage Protective Cover

Model #

DADPCB

Eva foam with PC film

With plastic hook

Applicable to SeaTouch 3 & 4 housing



SeaTouch 4 Max Travel Case

Model #

DADTCB

Water repellent surface with EVA foam

External dimension 250 x 150 x 95mm

Internal dimension 240 x 140 x 42mm

for both upper and lower part



The upper part is separated by a mesh fabric with zipper to protect the accessories from crashing onto the housing.



The lower part of the case is designed to contain the housing with the expansion clamp kit on.



Diving Equipment Coil Lanyard

Model # DADCL

Length 38 cm when buckled

145 cm when unbuckled



115cm extension when unbuckled



Outdoor Lanyard

Model # DADWS

Withstand 100kg tensile force

Can be dismantled and used as lifeline

Total length after disassembly is 350cm.



For dry gloves user, the non-conductive material of the gloves almost makes the touchscreen impossible. Therefore, the Underwater Touchscreen Finger Cot is designed to operate the SeaTouch housing by touch screen easily underwater.

Underwater Touchscreen Finger Cot

Model # DHUFC

Eva foam with elastic band

2 pieces per set

Use on dry suit gloves



Worry about removing the screen protector film on the phone? DIVEVOLK already has a solution for you. The Double Sided Phone Case provides a reusable front cover to protect your phone. Don't have to waste a protector film every time you use the housing.

Protective Case

Model # DADDDPC

Protect your phone 360°

Reusable front cover on the screen

Solve the trouble of removing the screen protector film every time you use the housing



SeaLink Contact-type Underwater Wi-Fi Signal Transmitter

Model # AW-11



Turn your phone into an underwater monitor



Control your camera by smartphone



Adjust brackets fits most housings



Touch Screen Focus (some DSLR models)

The SeaLink Contact-type Underwater Wi-Fi Signal Transmitter is a unique design that build up Wi-Fi connection between smartphone and camera underwater. Only by contacting on the surface of the housings without plugging in,can the signal be built up under the water. Through the camera application, the smartphone not only can be a monitor of the camera, but also adjust the parameter of the camera.





- Multi-angle adjustment monitor

- In-APP parameter adjustment, ISO, shutter speed, aperture and even touch-screen focus



- Photos and videos play-back in real time



Assembling details

The sensor can be assembled vertically or horizontally according to different uses.



Adjustable bracket fits the most housing size.



Notice:

The efficiency of Wi-Fi signal transmission is different from that of HDMI cable transmission. In some camera, there may be a slight delay or occasional freeze in image, which is normal.





CREATIVITY UNLIMITED

SeaTouch 4 Max Kits
Designed for different scenarios

Filters Kit

- Easy color restoration, with a suggestion use of depth between 5 to 25 meters.
- As for red filter and megenta filter, the red filter is for ocean and magenta filter is for fresh water, like river and lake.
- With the expansion clamp, the housing would be able to extend, such as, to attach on a tray, tripod or even dive lights.



SeaTouch 4 Max



Expansion Clamp



Filters



Protective Cover

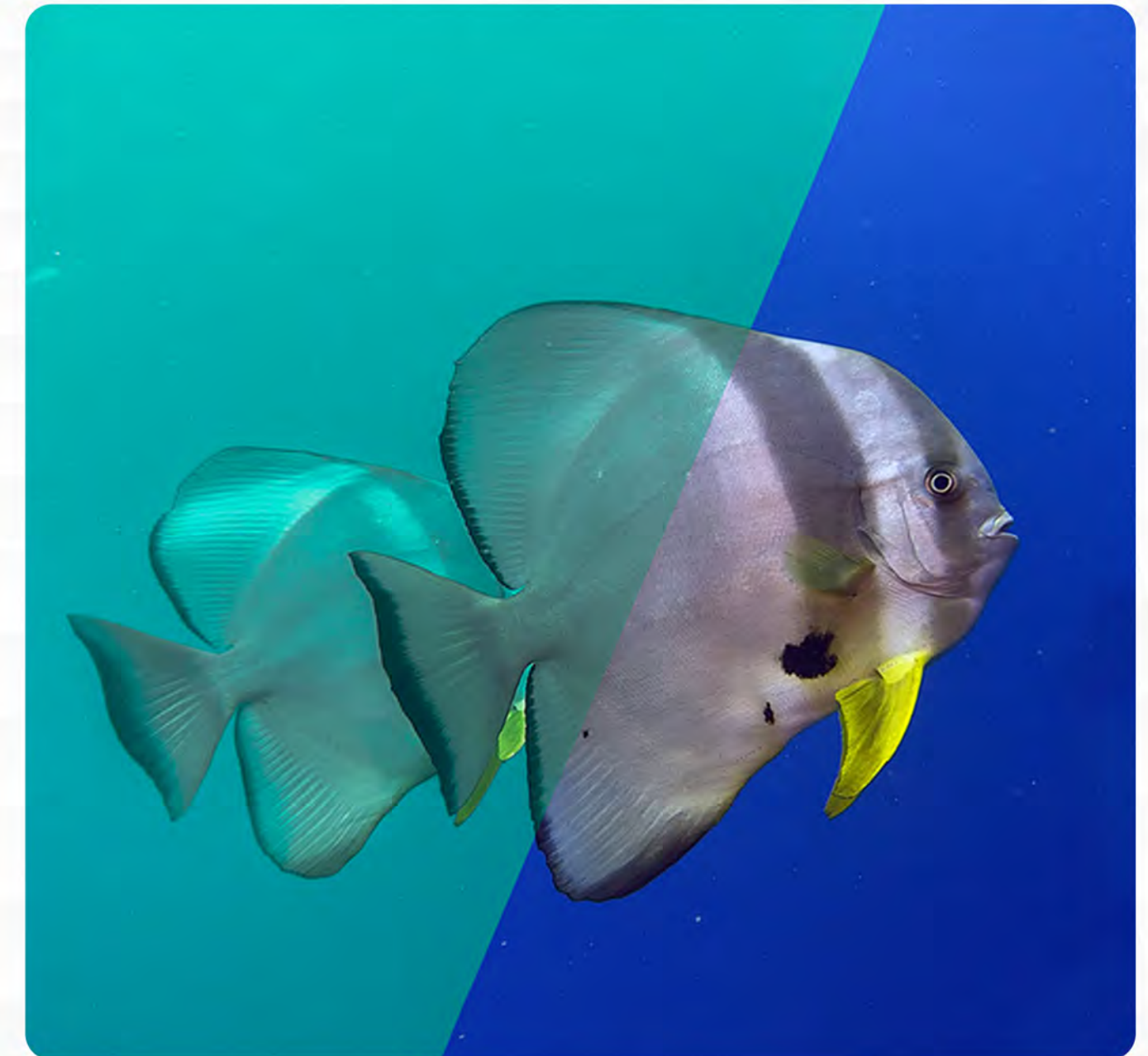

when diving in the ocean and the lake, as it gets deeper, more color is lost. Using a filter is the simplest way to restore the color underwater. This filter combo gives you the color back in water.

Water Sports Kit

- Easy to take photo and video in split shot with the dome lens.
- The water sports kit is a good fit for snorkelling, swimming pool shot, paddling and most of water sports.
- It's always float with the dome lens on, so no worry for dropping the phone into the sea.



Dome Lens



SeaTouch 4 Max



With the water sports kit, everyone can take split shot like a pro. It's easy to create half-half image or video with a dome lens, and you know how impressive the split shot is.

Macro Kit

■ The close-up lens provides the effect of magnification and diopter +15, which allows the camera to focus at a very short distance. Through the close-up lens, photos and videos could be shot with a milky smooth blurry background.

■ When creating macro content, lighting and stability is the key. SL20 video light provide the excellent illumination in a close distance. The flexible tripod keep the phone steady in even complicated landscape. All helps you to create amazing macro shots.



SeaTouch 4 Max



Expansion Clamp



Underwater Flexible Tripod



Close-up Lens +15



Ball Joint Clamp



M6 Ball Head



Video Light SL20



Protective cover

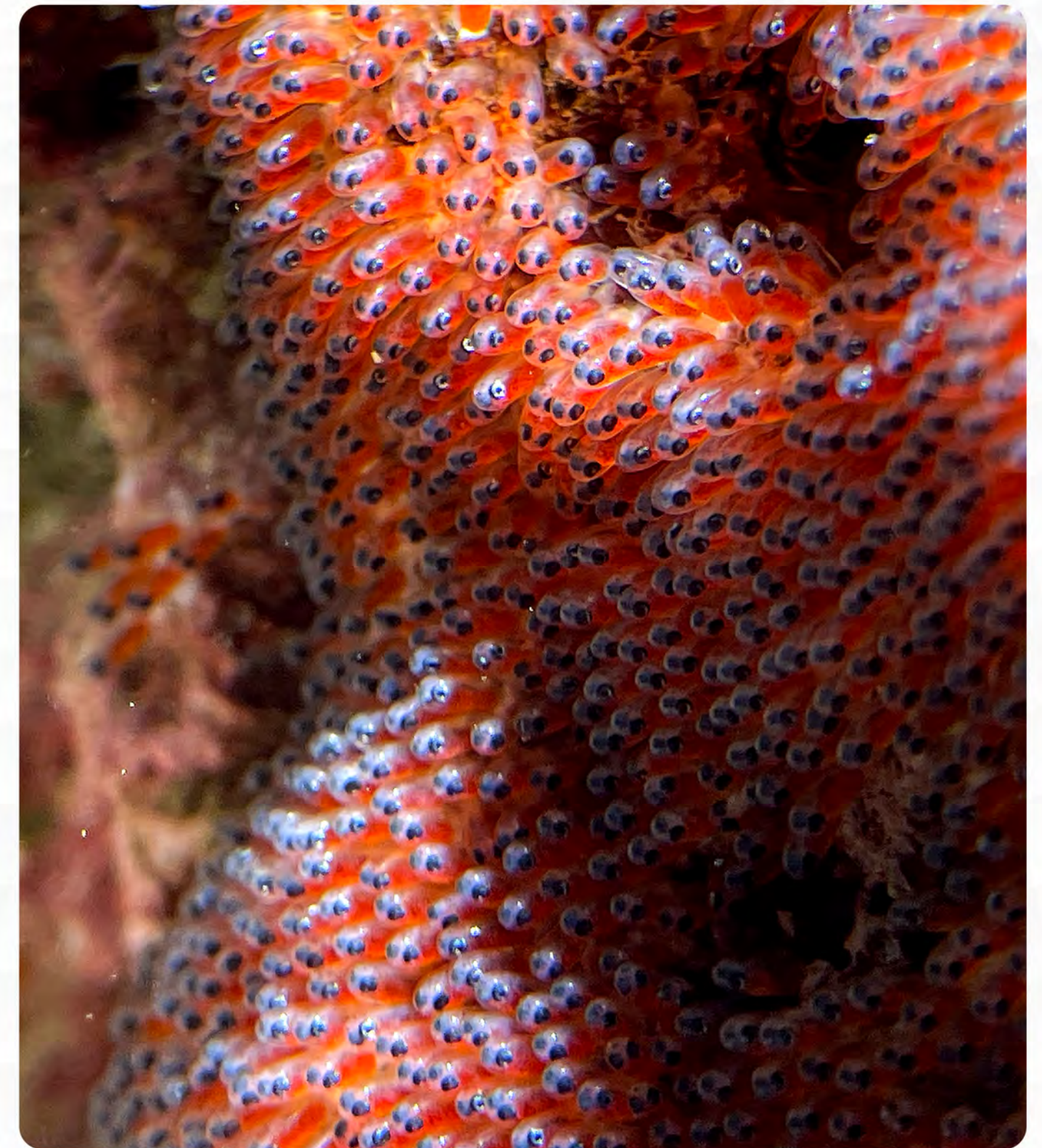

The macro world is fascinating once you discovered it. With the macro kit, You can get amazing photos and steady videos.

Ocean Kit

- The wide-angle lens not only corrects the underwater image distortion with an extraordinary capability, but also expand the view greatly.
- Red filter corrects the color in the ocean, making the image vivid and colorful.
- The wide-angle lens can be either attached on the red filter, or used separately.



If you want something handy yet powerful, you can put a set in a small box and take away. This wide-angle kit is the right option. Also it can be extended to other accessories easily, making it the most popular kit ever.



SeaTouch 4 Max



Expansion Clamp



Red Filter



Wide-angle Lens



Travel Case

Wide-Angle Lens

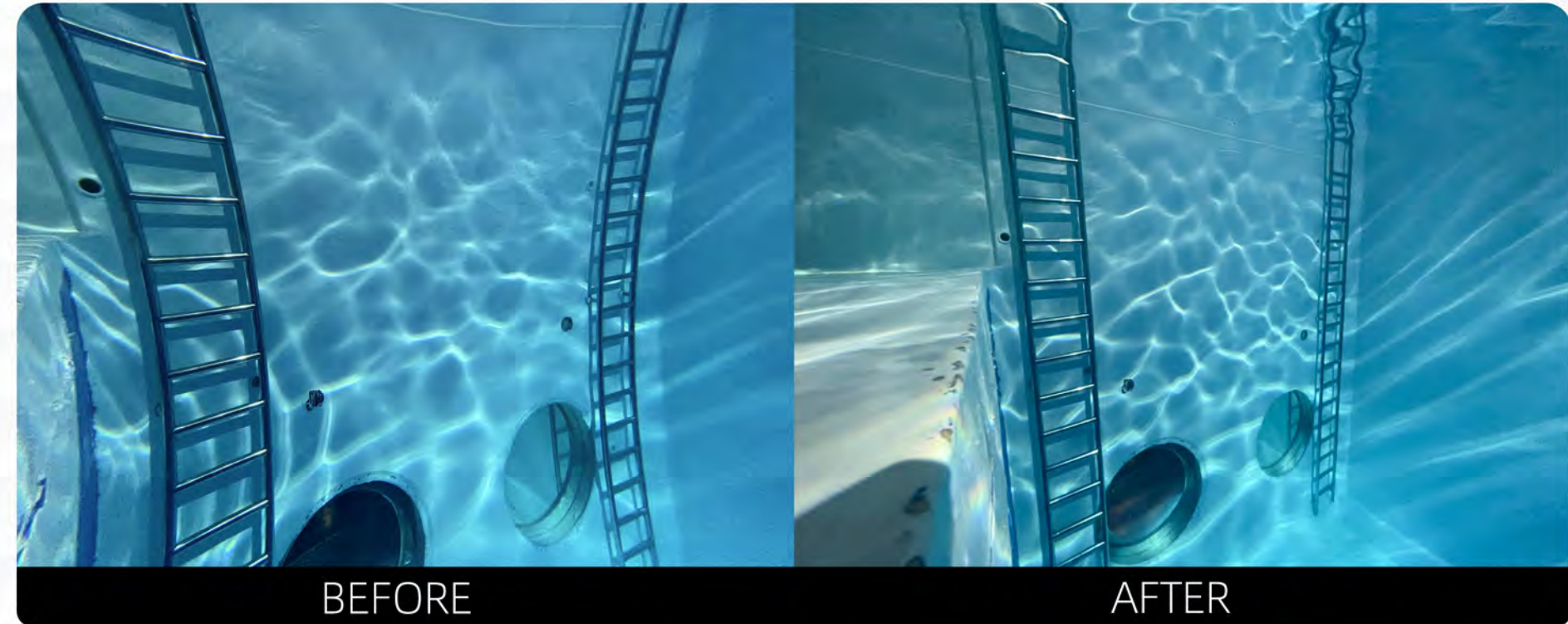

Red Filter



EXPAND YOUR GEAR FURTHER



Selfie Kit

Creator Kit



Ocean Kit

Videography Kit

Advanced Creator Kit



Selfie Kit



- Easy selfie shot with a selfie stick from 25cm to 75cm.
- Extend the selfie stick so you can put you phone closer to the object you want to film with less contact to it.



SeaTouch 4 Max



Expansion Clamp



Selfie Stick



Expansion Clamp



Red Filter



Travel Case

It's always good to see ourselves in the picture or video, especially in the ocean. If you don't want to bother others to shoot something for you, take the selfie kit and do it yourself.

Videography Kit

- Red filter and wide angle lens are the key accessories to create nice video with color restoration and distortion correction.
- In most condition, holding with both hands to take video would be more steady than one hand. The dual hand tray is designed to create steady shot.



SeaTouch 4 Max



Expansion Clamp



Red Filter



Wide-angle Lens



Dual Handle Tray



Travel Case



Like filming on land, underwater shooting needs concentration and good skills. The Wide-angle videography kit giving you the balance of compact and stability under the water.

Creator Kit

- 2000lm illumination is a good lighting condition for close shot, such as nemo, coral. With the light, you can make colorful and clear shot easily.
- Using a single handle tray to connect the housing and the SL20 video light will make it compact and light weight.



SeaTouch 4 Max



Expansion Clamp



Red Filter



Wide-angle Lens



Single Handle Tray



Ball Joint Clamp



Video Light
SL20



Travel Case



The single handle tray with an SL20 video light would be a balance of compact and capability. With this kit, you won't miss the amazing close shot.

Advanced Creator Kit

- With a 5000lm video light illumination, the color of your object would be restored properly, especially for close shot.
- The float arm can not only provide 447g buoyancy to compensate the weight of the video light, but also be an extension arm for the light to play with more angles.



Photography is the art of light and shadow. Try with light in different angles to create some special shots. You will never know how creative you are until you have one more try.



SeaTouch 4 Max



Expansion Clamp



Red Filter



Wide-angle Lens



Ball Joint Clamp x 2



Float Arm 447g



Video Light
SL50



M6 Ball Head



Travel Case

Almighty Kit

- With the Almighty Kit, you can create wide angle shot with good lighting condition by 2 of SL50 video lights, which you will need for deeper diving, bad visibility, wreck ship, etc.
- Red filter, wide angle lens and macro lens are the key accessories to create nice video with color restoration, distortion correction and close up shot. You can change the lens underwater to suit different scenarios.
- Using two float arms can reduce the weight greatly underwater and the arms could be an extension to make creative lighting in various angles.
- Protective cover and the travel case protects your housing from damage.





SeaTouch 4 Max



Expansion Clamp



Ball Joint Clamp x 4



Dual Handle Tray



Wide-angle Lens



Close-up Lens +15



Filters



Video Light
SL50 x 2



Travel Case



Protective Cover



Float Arm 447g X 2



Whether you like to shoot wide-angle or macro, video or photo, the almighty kit can meet your demands. You can also choose any combination to use underwater according to different scenarios to unleash your creativity.

Monitor Kit

Based on the camera's Wi-Fi function, we can use SeaLink to connect the phone to the camera underwater and use it as a camera monitor. With such a low-cost solution, you can get a large-screen camera monitor and enjoy the functions of the camera.



SeaTouch 4 Max



SeaLink Transmitter



Expansion Clamp



Ball Joint Clamp



1/4" Ball Head



Travel Case





LET'S
Explore the ocean
Capture the moment



DIVEVOLK

— Touch the future —



Website

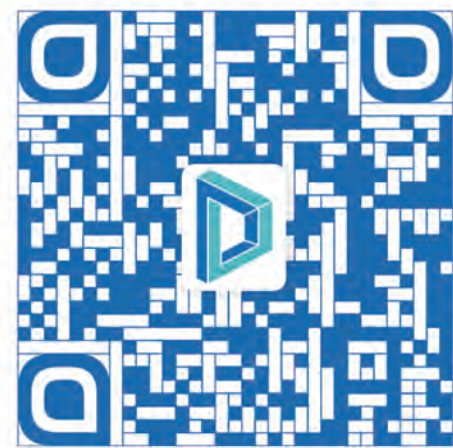

Facebook

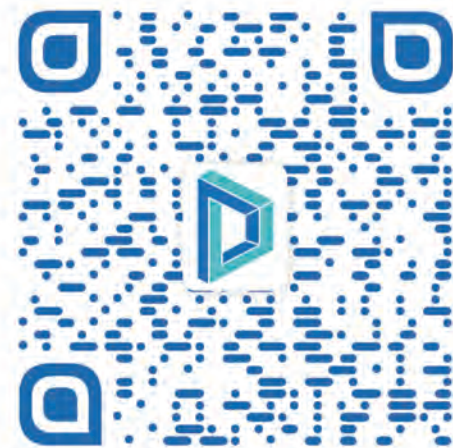

Instagram

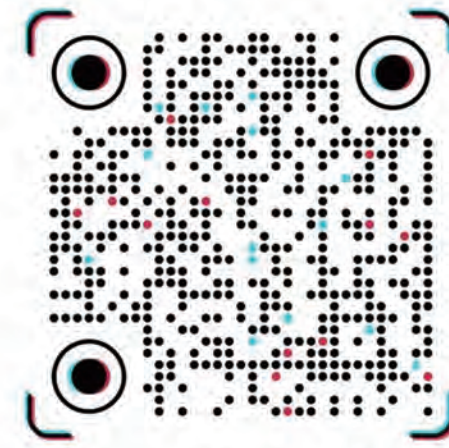

TikTok



YouTube



WeChat